

 **SIPAR**<sup>®</sup>

**R** **LLIGHT**<sup>®</sup>

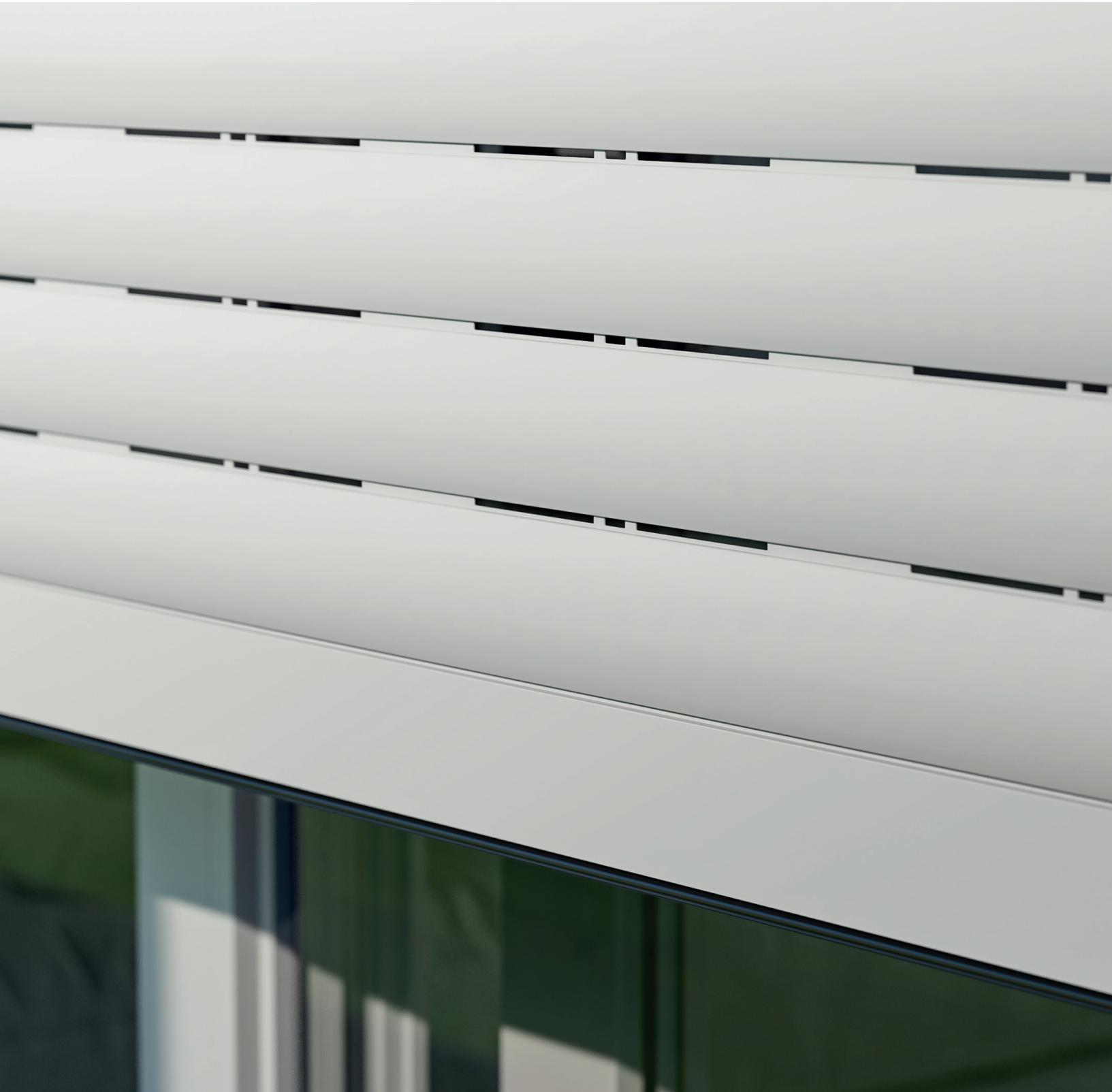

## Profilo curvo in alluminio coibentato

Insulated aluminum curved profile

Profil courbé en aluminium mousse



### PRODOTTO ECO COMPATIBILE

ECO-FRIENDLY PRODUCT  
PRODUIT ECO COMPATIBLE



### ISOLAMENTO TERMICO

THERMAL INSULATION  
ISOLATION THERMIQUE



### ISOLAMENTO ACUSTICO

ACUSTIC INSULATION  
ISOLATION ACOUSTIQUE



### ILLUMINAZIONE DEGLI AMBIENTI

LIGHTING OF THE ENVIRONMENTS  
ÉCLAIRAGE DES AMBIANCES



### RICIRCOLO DELL'ARIA NEGLI AMBIENTI

AIR RECIRCULATION IN THE ENVIRONMENTS  
RECYCLAGE D'AIR DANS LES AMBIANCES



### PREVIENE IL FORMARSI DELLE MUFFE

PREVENTS THE FORMATION OF MOLDS  
EMPÊCHE LA FORMATION DE MOISSURES

## CON ASOLATURA DECORATIVA

## WITH DECORATIVE SLOT / AVEC TROU DÉCORATIVE

DESIGN REGISTRATO / REGISTERED DESIGN / DESIGN ENREGISTRÉ

ITALY: 006316949-0001 / 006316949-0002 / 006316949-0003 / 006316949-0004 / 006316949-0005 / 006316949-0006

ISRAEL: 63527 / 63528 / 63529

### ASOLATURA / SLOT / TROU

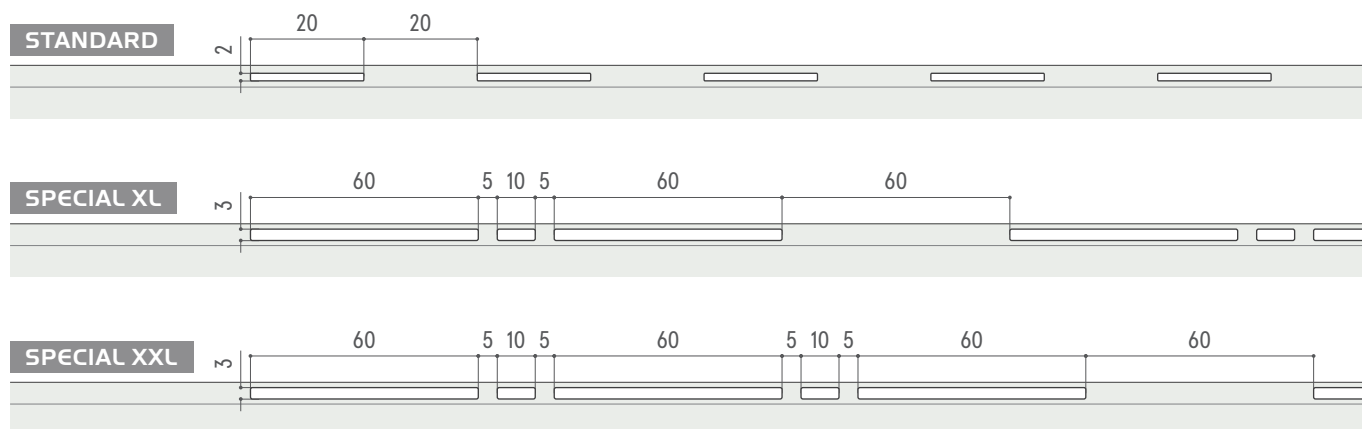

Nelle tapparelle ordinate su misura, le due asolature "SPECIAL" verranno combinate per garantire una distribuzione uniforme dei fori sulla lunghezza della stecca.

In the blinds ordered to measure, the two "SPECIAL" slots will be combined to ensure a uniform distribution of the holes along the length of the slat.

Dans les stores commandés sur mesure, les deux fentes « SPÉCIALES » seront combinées pour assurer une répartition uniforme des trous sur toute la longueur de la lamelle.

## CONFIGURAZIONI DISPONIBILI

CONFIGURATIONS AVAILABLE / CONFIGURATIONS DISPONIBLES

### ALLUMINIO / ALUMINUM / ALUMINIUM

**0,5 mm** **SPESSORE SUPER STRONG**  
SUPER STRONG THICKNESS / ÉPAISSEUR SUPER FORT



**0,3 mm** **SPESSORE STANDARD**  
STANDARD THICKNESS / ÉPAISSEUR STANDARD

### POLIURETANO / POLYURETHANE / POLYURÉTHANE

**300 Kg/m<sup>3</sup>** **ALTA DENSITÀ**  
HIGH DENSITY / HAUTE DENSITÉ

**65 Kg/m<sup>3</sup>** **DENSITÀ STANDARD**  
STANDARD DENSITY / DENSITÉ STANDARD

### VERNICIATURA / PAINTING / PEINTURE

**SUPER DURA**  
SUPER HARD / SUPER DUR

**DURA**  
HARD / DUR



### DESIGN ESTERNO / EXTERIOR DESIGN / DESIGN EXTÉRIEUR

**LISCIO**  
SMOOTH / LISSE

**RIGATO**  
STRIPED / RAYÉ

# TR52 0,3 mm

## Profilo curvo in alluminio coibentato

Insulated aluminum curved profile

Profil courbé en aluminium mousse

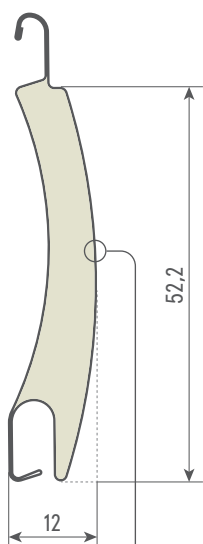
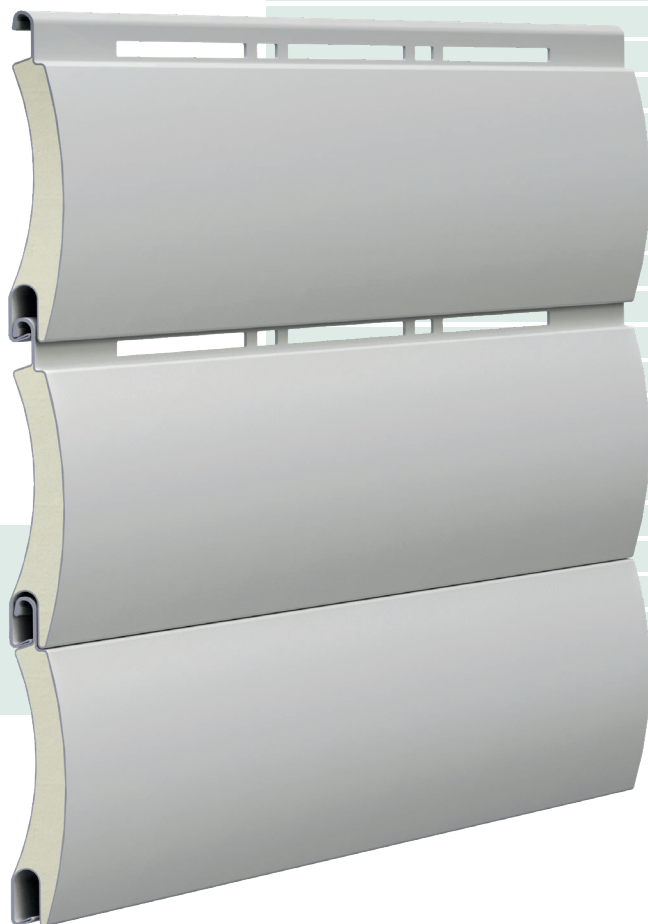

~0,328 mm

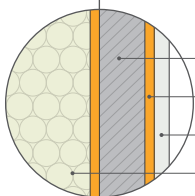

### Caratteristiche

Features / Caractéristiques

<b>Dimensioni / Dimensions / Dimensions</b>	mm	12 x 52,2
<b>Peso al mq (DENSITÀ STANDARD) / Weight for sqm (STANDARD DENSITY) / Poids au m<sup>2</sup> (DENSITÉ STANDARD)</b>	kg	~ 3,2
<b>Peso al mq (ALTA DENSITÀ) / Weight for sqm (HIGH DENSITY) / Poids au m<sup>2</sup> (HAUTE DENSITÉ)</b>	kg	~ 4,8
<b>Profili per mt di altezza / Profiles for meter in height / Profils pour un mètre de hauteur</b>	n	19

### Asolatura / Hole / Trou

STANDARD

SPECIAL XL

SPECIAL XXL

Vedere pag. 1 per dimensioni e disegno delle asolature

See p. 1 for dimensions and design of the slots / Voir p. 1 pour les dimensions et la conception des trous

<b>ALLUMINIO / ALUMINUM / ALUMINIUM</b>	mm	~ 0,3
<b>PRIMER / PRIMER / PRIMAIRE</b>	µm	~ 4 + 4
<b>VERNICE CON PROTEZIONE UV / PAINT UV PROTECTION / PEINTURE AVEC PROTECTION UV</b>	µm	~ 20
<b>DENSITÀ POLIURETANO / POLYURETHANE DENSITY / DENSITÉ POLYURÉTHANE</b>	kg/m <sup>3</sup>	~ 65 / 300

### Imballaggio e codici

Packaging and codes / Emballage et codes



Per codici e imballaggi degli articoli fare riferimento alle tabelle a pag. 9-10

For item codes and packaging, refer to the tables on page. 9-10 / Pour les codes d'articles et l'emballage, reportez-vous aux tableaux à la page. 9-10

GUIDE / GUIDES / COULISSES

P19

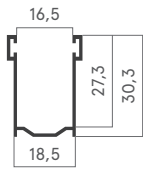

P24

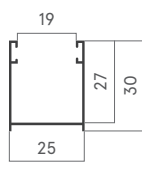

P26

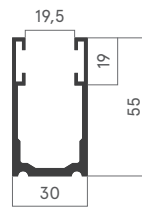

PM40

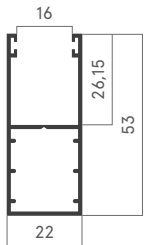

PM41

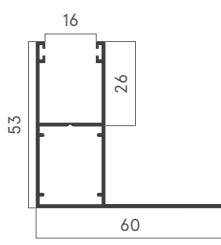

PM42

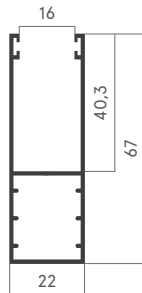

PM44

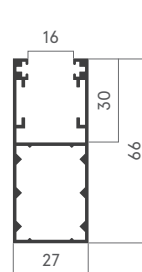

TERMINALI / END SLATS / LAME FINALES

TM39



TM40

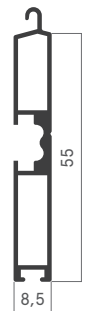

TM50

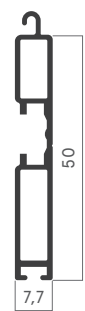

GUARNIZIONI / GASKET / JOINT

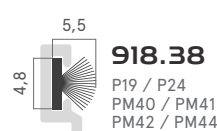
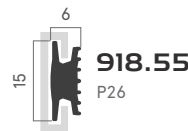
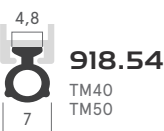
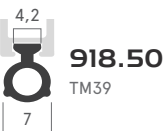

**Con cianfrinatura standard SIPAR®**  
With standard SIPAR® crimping  
Avec sertissage standard SIPAR®

**Con tappo tradizionale**  
With standard plug  
Avec bouchon standard

**909.57M**  
**TAPPO ANTIUSURA E ANTIRUMORE**  
ANTI-WEARING AND ANTINOISE PLUG  
BOUCHON ANTI-USURE ET ANTI-BRUIT

**Con tappo a sormonto**  
With overlap plug  
Bouchon avec recouvrement

**909.575C**  
**TAPPO ANTIUSURA E ANTIRUMORE**  
ANTI-WEARING AND ANTINOISE PLUG  
BOUCHON ANTI-USURE ET ANTI-BRUIT

**SP3733**  
VITE / SCREW / VIS

Installazione

Installation / Installation

H	Ø 60 mm		Ø 70 mm	
	D	D	D	D
mm	mm	mm	mm	mm
1000	150	140	165	150
1200	150	150	160	160
1400	160	160	180	165
1600	170	170	180	170
1800	175	175	180	180
2000	180	180	190	190
2200	205	195	205	195
2400	200	200	205	205
2600	250	205	250	205
2800	210	210	250	215
3000	225	225	250	225

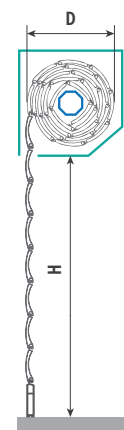

Dimensione massima / Maximum size / Taille maximale

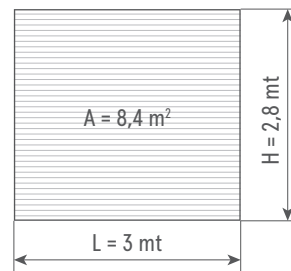

DENSITÀ STANDARD  
STANDARD DENSITY / DENSITÉ STANDARD

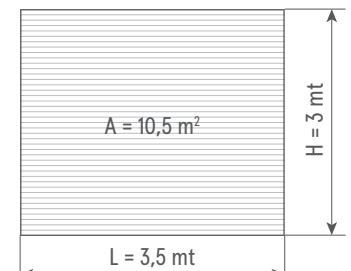

ALTA DENSITÀ  
HIGH DENSITY / HAUTE DENSITÉ

COLORI DISPONIBILI / AVAILABLE COLOR / COULEURS DISPONIBLES

FINITURA OPACA / MATT FINISHING / FINITION OPAQUE

01M RAL9003	02M RAL7021	03M RAL1013	04M BRONZO	05M RAL9007	06M RAL9006	07M RAL7024	08M RAL7046	09M RAL7022	10M RAL9005	11M RAL7035	12M RAL7012	13M RAL7038	14M RAL9001
15M RAL9002	16M RAL9016	17M RAL7047	18M RAL7040	19M RAL7042	20M RAL7043	21M RAL7039	22M RAL7032	23M RAL7031	24M RAL7011	25M RAL7015	26M RAL7016	27M RAL7005	28M RAL7010

## TR52 0,5 mm



### Profilo curvo in alluminio coibentato

Insulated aluminum curved profile

Profil courbé en aluminium mousse

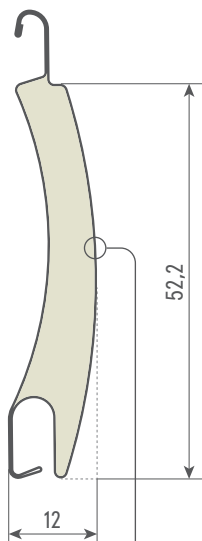
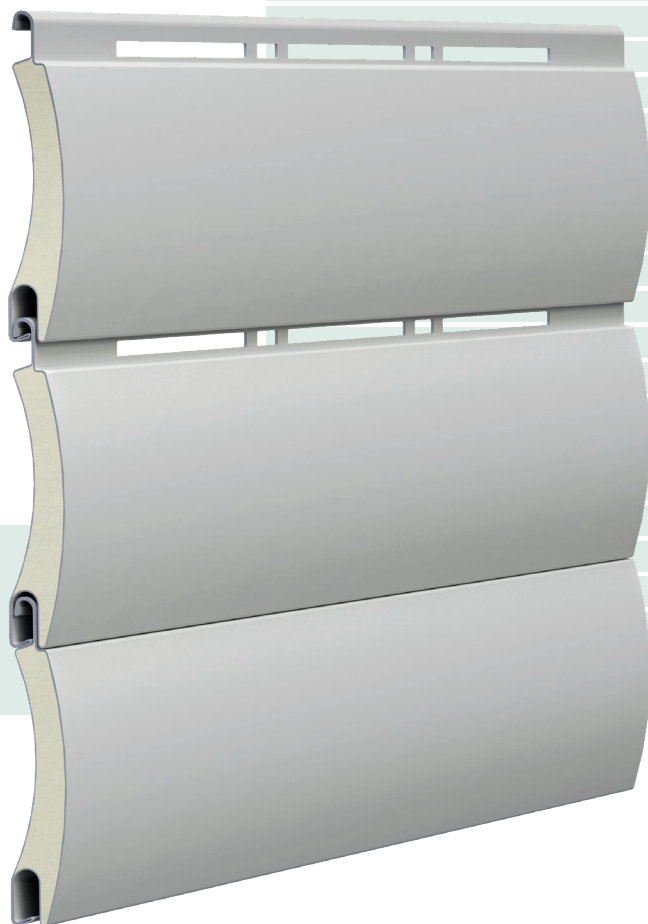

~ 0,528 mm

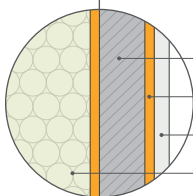

### Caratteristiche

Features / Caractéristiques

<b>Dimensioni / Dimensions / Dimensions</b>	mm	12 x 52,2
<b>Peso al mq (DENSITÀ STANDARD) / Weight for sqm (STANDARD DENSITY) / Poids au m<sup>2</sup> (DENSITÉ STANDARD)</b>	kg	~ 5,4
<b>Peso al mq (ALTA DENSITÀ) / Weight for sqm (HIGH DENSITY) / Poids au m<sup>2</sup> (HAUTE DENSITÉ)</b>	kg	~ 6,7
<b>Profili per mt di altezza / Profiles for meter in height / Profils pour un mètre de hauteur</b>	n	19

### Asolatura / Hole / Trou

STANDARD

SPECIAL XL

SPECIAL XXL

Vedere pag. 1 per dimensioni e disegno delle asolature

See p. 1 for dimensions and design of the slots / Voir p. 1 pour les dimensions et la conception des trous

<b>ALLUMINIO / ALUMINUM / ALUMINIUM</b>	mm	~ 0,5
<b>PRIMER / PRIMER / PRIMAIRE</b>	µm	~ 4 + 4
<b>VERNICE CON PROTEZIONE UV / PAINT UV PROTECTION / PEINTURE AVEC PROTECTION UV</b>	µm	~ 20
<b>DENSITÀ POLIURETANO / POLYURETHANE DENSITY / DENSITÉ POLYURÉTHANE</b>	kg/m <sup>3</sup>	~ 65 / 300

### Imballaggio e codici

Packaging and codes / Emballage et codes



Per codici e imballaggi degli articoli fare riferimento alle tabelle a pag. 9-10

For item codes and packaging, refer to the tables on page. 9-10 / Pour les codes d'articles et l'emballage, reportez-vous aux tableaux à la page. 9-10



GUIDE / GUIDES / COULISSES

P19

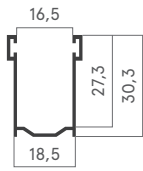

P24

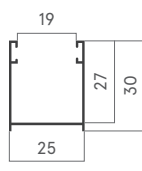

P26

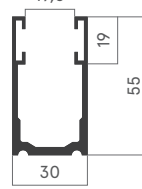

PM40

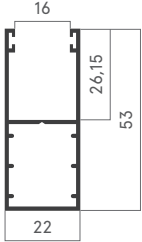

PM41

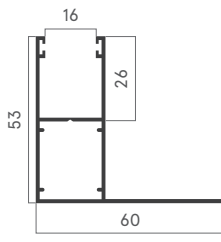

PM42

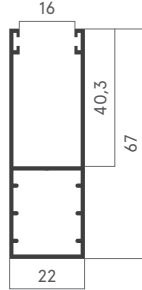

PM44

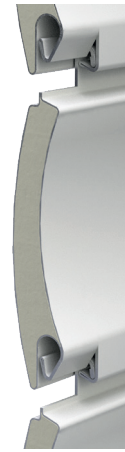
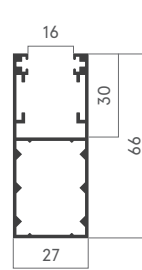

Con cianfrinatura standard SIPAR®

With standard SIPAR® crimping  
Avec sertissage standard SIPAR®

Con tappo tradizionale

With standard plug  
Avec bouchon standard



909.57M

TAPPO ANTIUSURA E ANTIRUMORE  
ANTI-WEARING AND ANTINOISE PLUG  
BOUCHON ANTI-USURE ET ANTI-BRUIT

Con tappo a sormonto

With overlap plug  
Bouchon avec recouvrement



909.575C

TAPPO ANTIUSURA E ANTIRUMORE  
ANTI-WEARING AND ANTINOISE PLUG  
BOUCHON ANTI-USURE ET ANTI-BRUIT

SP3733  
VITE / SCREW / VIS

TERMINALI / END SLATS / LAME FINALES

TM39



TM40



TM50

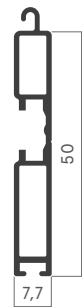

GUARNIZIONI / GASKET / JOINT

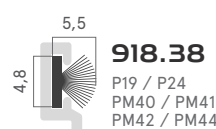
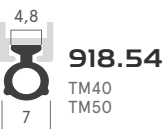
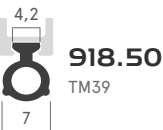

H	Ø 60 mm		Ø 70 mm	
	D	D	D	D
mm	mm	mm	mm	mm
1000	150	140	165	150
1200	165	150	180	160
1400	165	160	180	165
1600	180	170	180	170
1800	180	175	180	180
2000	205	180	205	190
2200	205	195	205	195
2400	205	200	205	200
2600	250	205	250	205
2800	250	210	250	215
3000	250	225	250	225

Installazione

Installation / Installation

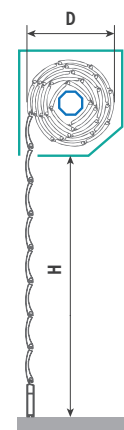

Dimensione massima / Maximum size / Taille maximale

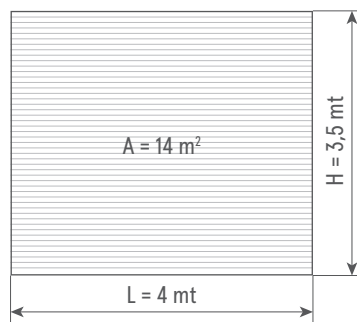

DENSITÀ STANDARD  
STANDARD DENSITY / DENSITÉ STANDARD

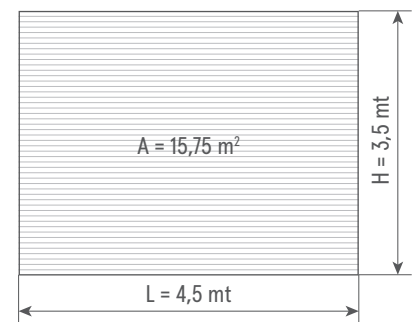

ALTA DENSITÀ  
HIGH DENSITY / HAUTE DENSITÉ

COLORI DISPONIBILI / AVAILABLE COLOR / COULEURS DISPONIBLES

FINITURA OPACA / MATT FINISHING / FINITION OPAQUE

01M RAL9003	02M RAL7021	03M RAL1013	04M BRONZO	05M RAL9007	06M RAL9006	07M RAL7024	08M RAL7046	09M RAL7022	10M RAL9005	11M RAL7035	12M RAL7012	13M RAL7038	14M RAL9001
15M RAL9002	16M RAL9016	17M RAL7047	18M RAL7040	19M RAL7042	20M RAL7043	21M RAL7039	22M RAL7032	23M RAL7031	24M RAL7011	25M RAL7015	26M RAL7016	27M RAL7005	28M RAL7010







**ROLLIGHT<sup>®</sup>**

 **SIPAR<sup>®</sup>**











In fase d'ordine specificare la tipologia di profilo con la verniciatura desiderata, facendo riferimento alle tabelle sottostanti. Durante la fase d'ordine per le tapparelle su misura (telo) è necessario scegliere anche la tipologia di assemblaggio del telo.

When ordering, specify the type of profile with the desired paint, referring to the tables below. During the ordering phase for custom-made roller shutters (fabric) it is also necessary to choose the type of fabric assembly.

Lors de la commande, précisez le type de profilé avec la peinture souhaitée, en vous référant aux tableaux ci-dessous. Lors de la phase de commande des volets roulants sur mesure (tissu) il faut également choisir le type d'assemblage de la toile.

CODICI PROFILI / PROFILES CODES / CCODES DE PROFILS

**PROFILO LISCIO**  
SMOOTH PROFILE / PROFIL LISSE

Tipologia Typology Typologie	Asolatura Slot Trou	Poliuretano Polyurethane polyuréthane	Alluminio Aluminum Aluminium	n			Codice / Art / Reference	
<b>Telo</b> Shutter Volet 	<b>STANDARD</b> 	65 Kg/m³	0,3 mm	-	-	-	TR52222 365ST/LI	
			0,5 mm	-	-	-	TR52222 565ST/LI	
		300 Kg/m³	0,3 mm	-	-	-	TR52222 330ST/LI	
			0,5 mm	-	-	-	TR52222 530ST/LI	
		<b>SPECIAL XL</b> 	65 Kg/m³	0,3 mm	-	-	-	TR52222 365XL/LI
				0,5 mm	-	-	-	TR52222 565XL/LI
	300 Kg/m³		0,3 mm	-	-	-	TR52222 330XL/LI	
			0,5 mm	-	-	-	TR52222 530XL/LI	
	<b>SPECIAL XXL</b> 		65 Kg/m³	0,3 mm	-	-	-	TR52222 365XXL/LI
				0,5 mm	-	-	-	TR52222 565XXL/LI
		300 Kg/m³	0,3 mm	-	-	-	TR52222 330XXL/LI	
			0,5 mm	-	-	-	TR52222 530XXL/LI	
<b>Profili</b> Profiles Profils 		<b>STANDARD</b> 	65 Kg/m³	0,3 mm	-	-	-	TR52650 365ST/LI
				0,5 mm	-	-	-	TR52650 565ST/LI
	300 Kg/m³		0,3 mm	-	-	-	TR52650 330ST/LI	
			0,5 mm	-	-	-	TR52650 530ST/LI	
	<b>SPECIAL XL</b> 		65 Kg/m³	0,3 mm	-	-	-	TR52650 365XL/LI
				0,5 mm	-	-	-	TR52650 565XL/LI
		300 Kg/m³	0,3 mm	-	-	-	TR52650 330XL/LI	
			0,5 mm	-	-	-	TR52650 530XL/LI	
		<b>SPECIAL XXL</b> 	65 Kg/m³	0,3 mm	-	-	-	TR52650 365XXL/LI
				0,5 mm	-	-	-	TR52650 565XXL/LI
	300 Kg/m³		0,3 mm	-	-	-	TR52650 330XXL/LI	
			0,5 mm	-	-	-	TR52650 530XXL/LI	

(\*) Nelle tapparelle ordinate su misura, le due asolature "SPECIAL" verranno combinate per garantire una distribuzione uniforme dei fori in funzione della larghezza della tapparella.

(\*) In the blinds ordered to measure, the two "SPECIAL" slots will be combined to ensure a uniform distribution of the holes according to the width of the rolling shutter.



(\*) Dans les stores commandés sur mesure, les deux aiourages « SPÉCIALES » seront combinés pour assurer une répartition uniforme des trous selon la largeur du volet roulant.

Verniciatura / Painting / Peinture		Colore / Color / Couleur		Assemblaggio tapparella Shutters assembling / assemblage du volet	
TIPOLOGIA / TYPOLOGY / TYPOLOGIE	CODICE / CODE	CODICE / CODE		TIPOLOGIA / TYPOLOGY / TYPOLOGIE	CODICE / CODE
DURA HARD / DUR	D	VEDI CODICI P. 4-6 SEE CODES P. 4-6 VOIR CODES P. 4-6		CIANFRINATURA STANDARD SIPAR® STANDARD SIPAR® CRIMPING / SERTISSAGE STANDARD SIPAR®	04
				TAPPO TRADIZIONALE STANDARD PLUG / BOUCHON STANDARD	05
SUPER DURA ULTRA HARD / ULTRA DUR	SD			TAPPO A SORMONTO OVERLAP PLUG / BOUCHON AVEC RECOUVREMENT	06

**SD7404** Esempio codice per finitura  
Code example for finishing / Exemple de code pour la finition

**Solo per teli su misura**  
Only for made-to-measure shutter / Uniquement pour les volet sur mesure

 **PROFILO RIGATO**  
STRIPED PROFILE / PROFIL RAYÉ

Tipologia Typology Typologie	Asolatura Slot Trou	Poliuretano Polyurethane polyuréthane	Alluminio Aluminum Aluminium	n	L		Codice / Art / Reference	
<b>Telo</b> Shutter Volet 	STANDARD - - - - -	65 Kg/m³	0,3 mm	-	-	-	TR52222 365ST/RI	
			0,5 mm	-	-	-	TR52222 565ST/RI	
		300 Kg/m³	0,3 mm	-	-	-	TR52222 330ST/RI	
			0,5 mm	-	-	-	TR52222 530ST/RI	
		SPECIAL XL - - - - -	65 Kg/m³	0,3 mm	-	-	-	TR52222 365XL/RI
				0,5 mm	-	-	-	TR52222 565XL/RI
	300 Kg/m³		0,3 mm	-	-	-	TR52222 330XL/RI	
			0,5 mm	-	-	-	TR52222 530XL/RI	
	SPECIAL XXL - - - - -	65 Kg/m³	0,3 mm	-	-	-	TR52222 365XXL/RI	
			0,5 mm	-	-	-	TR52222 565XXL/RI	
		300 Kg/m³	0,3 mm	-	-	-	TR52222 330XXL/RI	
			0,5 mm	-	-	-	TR52222 530XXL/RI	
<b>Profili</b> Profiles Profils 		STANDARD - - - - -	65 Kg/m³	0,3 mm	-	-	-	TR52650 365ST/RI
				0,5 mm	-	-	-	TR52650 565ST/RI
	300 Kg/m³		0,3 mm	-	-	-	TR52650 330ST/RI	
			0,5 mm	-	-	-	TR52650 530ST/RI	
	SPECIAL XL - - - - -		65 Kg/m³	0,3 mm	-	-	-	TR52650 365XL/RI
				0,5 mm	-	-	-	TR52650 565XL/RI
		300 Kg/m³	0,3 mm	-	-	-	TR52650 330XL/RI	
			0,5 mm	-	-	-	TR52650 530XL/RI	
	SPECIAL XXL - - - - -	65 Kg/m³	0,3 mm	-	-	-	TR52650 365XXL/RI	
			0,5 mm	-	-	-	TR52650 565XXL/RI	
		300 Kg/m³	0,3 mm	-	-	-	TR52650 330XXL/RI	
			0,5 mm	-	-	-	TR52650 530XXL/RI	

(\*) Nelle tapparelle ordinate su misura, le due asolature "SPECIAL" verranno combinate per garantire una distribuzione uniforme dei fori in funzione della larghezza della tapparella.

(\*) In the blinds ordered to measure, the two "SPECIAL" slots will be combined to ensure a uniform distribution of the holes according to the width of the rolling shutter.

(\*) Dans les stores commandés sur mesure, les deux aiourages « SPÉCIALES » seront combinés pour assurer une répartition uniforme des trous selon la largeur du volet roulant.



**SIPAR S.R.L**

25050 Pian Camuno (BS) Italy - Via Saletti, 5

Tel. +39 0364 598993 - Fax. +39 0364 598 996

[www.siparonline.com](http://www.siparonline.com) - email: [info@siparonline.com](mailto:info@siparonline.com)



**SIPAR ISRAEL**

Hayotzrim 9 - Karmiel - Israel

Tel. 00972 48665547 - Fax. 00972 48686571

[www.siparisrael.com](http://www.siparisrael.com) - [office@siparisrael.com](mailto:office@siparisrael.com)

